



SPITFIRE DOORS

THE ART OF PERFECTION

S-600 PIVOT DOORS

WELCOME TO SPITFIRE DOORS,
THE WORLD'S MOST EXCLUSIVE
COLLECTION OF LUXURY
RESIDENTIAL ENTRANCE DOORS.

PIVOTS. DOORS WITH ATTITUDE

Pivot doors are wider and taller by design. Their sheer scale allows you to be creative when designing an awesome entrance to your property.

The inherent strength of our pivot door frame combined with our clever pivot mechanism means that a Spitfire pivot door is capable of carrying heavy external finishes like ceramic, laminated glass or wood, with ease.

Pivot doors are definitely 'on trend' and always create a stunning first impression.

"The details are not the design,
they make the design."
- Charles Eames



THE ART OF PERFECTION

DESIGN OPTIONS

Our S-600 Pivot doors can be manufactured from a minimum size of 1000mm wide x 2000mm high up to a maximum size of 1500mm wide x 3000mm high. By special arrangement, we can manufacture Pivot doors up to 2000mm wide x 6000mm high in our S-700 Pivot Series.

Our pivot threshold is virtually flush at floor level, so it is very important to consider your internal floor finishing material (marble, tile, carpet) before ordering your door. A hidden weatherbar drops down inside the door as it is closing but it is always best to have a non-permeable internal floor material behind a pivot door.

Spitfire pivot's can be dressed in exciting finishes, including stainless steel, carbon-fibre effect, stone, aluminium, rare natural wood, eco-lacquered wood, corten or laminated glass.

Doors with matching solid side frames or glazed side elements are also available.

Spitfire pivots can be installed within a Spitfire aluminium curtain wall assembly or into brick, stone or steel.

The thermal performance of our pivot doors will vary slightly by finishing material, but they are always below 1.0 W/m²K, which is way below current Building Regulation requirements.

"Beauty is the harmony
of function and form."

- Alvar Aalto





408

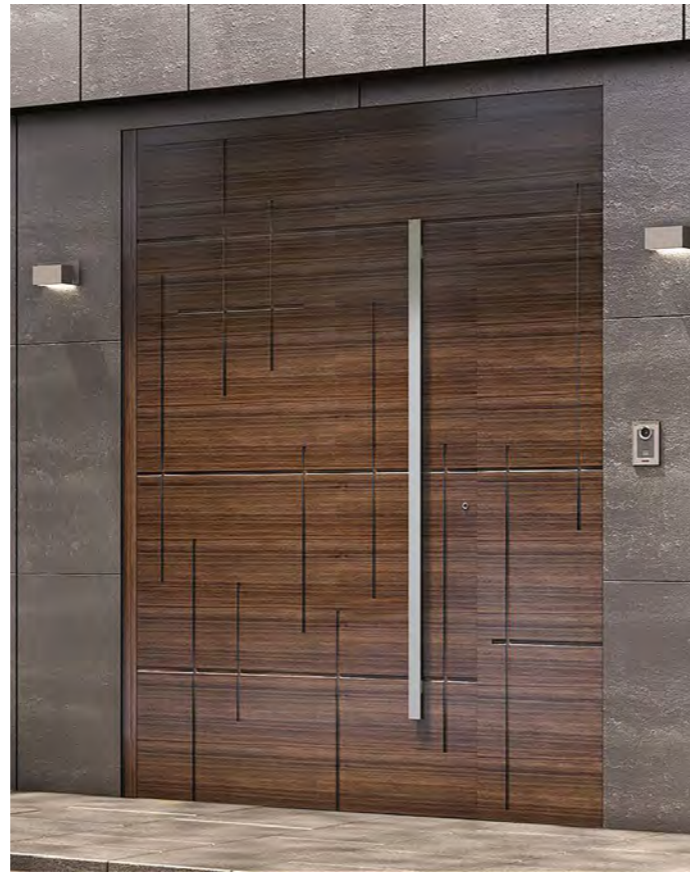

414



Geometric



406



442



482



Geometric



416



406



465



446



446

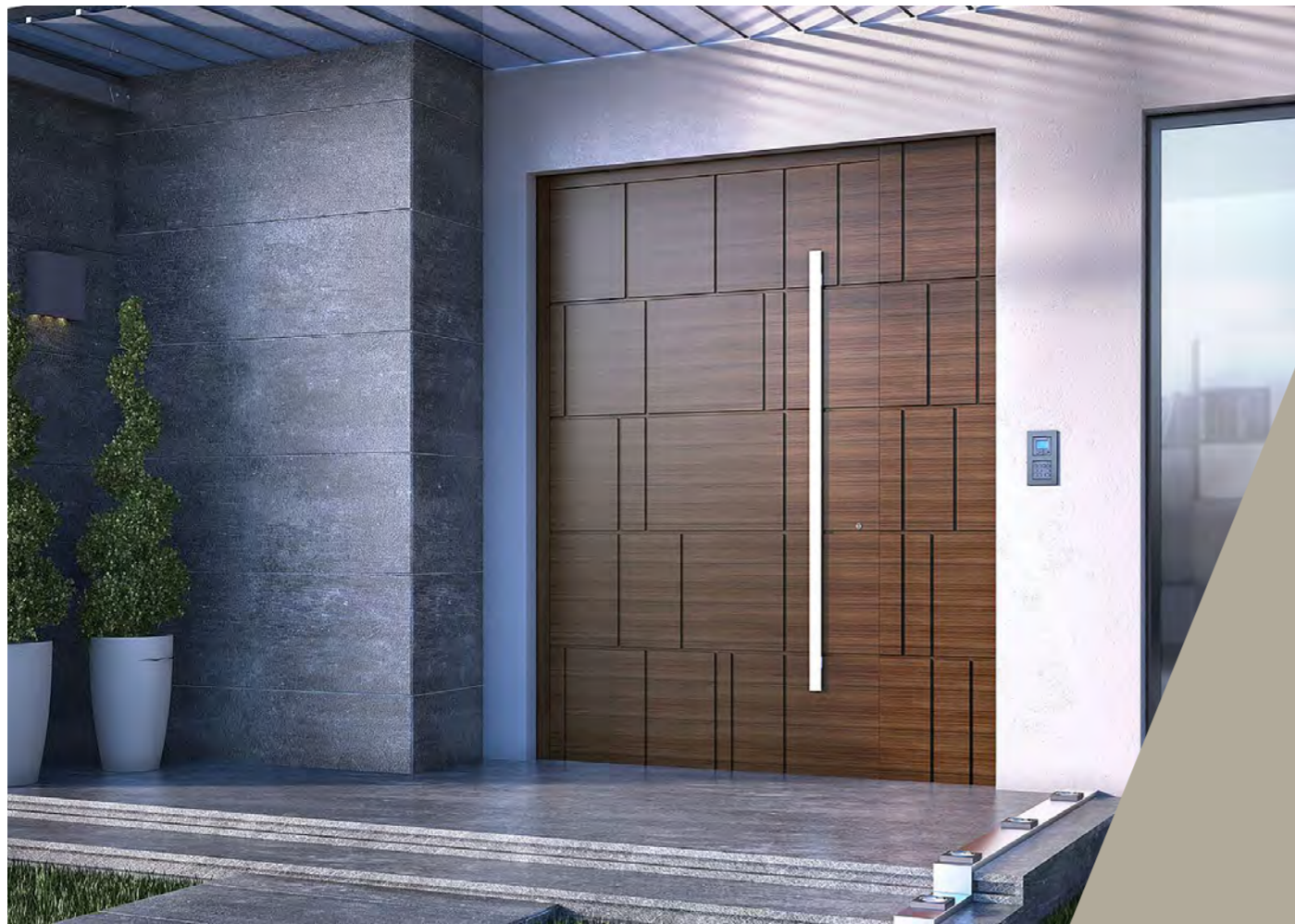

408



410



400



406



400



400



410



444



412

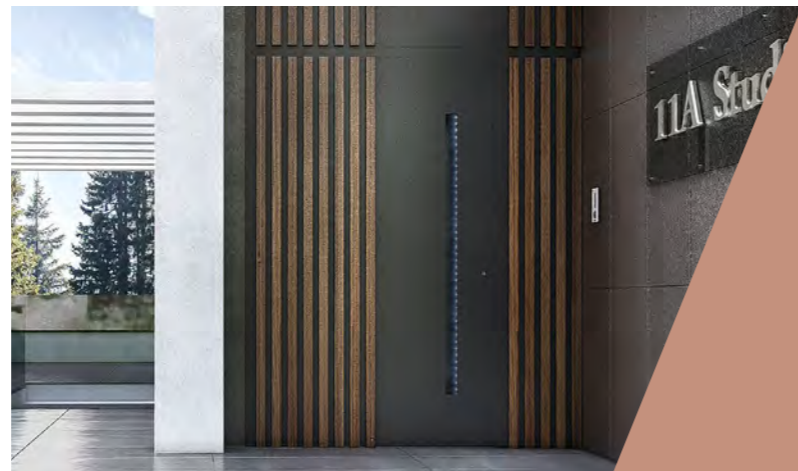

468



414

UNIQUE FEATURES

DOOR FRAME

- Our 1.5mm thick aluminium door frame is 80mm deep (front to back)

DOOR ACCESSORIES

A special recessed external handle, with built-in LED's is a fabulous feature, available on many of our pivot door designs. Or you can choose a luxury square or round pullbar handle in a stainless steel or black finish externally, with a lever handle internally.

Fingerprint readers are a highly desirable upgrade and of course, we allow you to add Swarovski® crystals to most Spitfire pivot doors.

PERFORMANCE

Each Pivot door is slightly different depending on the material you choose, but in general our doors achieve:

- Class 3 Air Tightness
- Class 1A Water Tightness
- C3 Wind Load Resistance
- Soundproof to 31 decibels

"Sometimes, less is more."
- William Shakespeare



RAL FINISHES AVAILABLE

Colours shown are for illustrative purposes only. Please request a colour swatch before ordering your door.

RAL colours available in a choice of matt or textured finish

RAL 1013 Matt	RAL 1013 Textured	RAL 1015 Matt	RAL 1015 Textured	RAL 1019 Matt	RAL 1019 Textured	RAL 3004 Matt	RAL 3004 Textured	RAL 3005 Matt
RAL 3005 Textured	RAL 5002 Matt	RAL 5002 Textured	RAL 5003 Matt	RAL 5003 Textured	RAL 5005 Matt	RAL 5005 Textured	RAL 5009 Matt	RAL 5009 Textured
RAL 5010 Matt	RAL 5010 Textured	RAL 5014 Matt	RAL 5014 Textured	RAL 5015 Matt	RAL 5015 Textured	RAL 5024 Matt	RAL 5024 Textured	RAL 6003 Matt
RAL 6003 Textured	RAL 6005 Matt	RAL 6005 Textured	RAL 6009 Matt	RAL 6009 Textured	RAL 7001 Matt	RAL 7001 Textured	RAL 7005 Matt	RAL 7005 Textured
RAL 7006 Matt	RAL 7006 Textured	RAL 7011 Matt	RAL 7011 Textured	RAL 7012 Matt	RAL 7012 Textured	RAL 7015 Matt	RAL 7015 Textured	RAL 7016 Matt
RAL 7016 Textured	RAL 7021 Matt	RAL 7021 Textured	RAL 7022 Matt	RAL 7022 Textured	RAL 7023 Matt	RAL 7023 Textured	RAL 7024 Matt	RAL 7024 Textured
RAL 7030 Matt	RAL 7030 Textured	RAL 7031 Matt	RAL 7031 Textured	RAL 7033 Matt	RAL 7033 Textured	RAL 7034 Matt	RAL 7034 Textured	RAL 7035 Matt
RAL 7035 Textured	RAL 7037 Matt	RAL 7037 Textured	RAL 7038 Matt	RAL 7038 Textured	RAL 7039 Matt	RAL 7039 Textured	RAL 7040 Matt	RAL 7040 Textured
RAL 7042 Matt	RAL 7042 Textured	RAL 7044 Matt	RAL 7044 Textured	RAL 8011 Matt	RAL 8011 Textured	RAL 8014 Matt	RAL 8014 Textured	RAL 8017 Matt
RAL 8017 Textured	RAL 8019 Matt	RAL 8019 Textured	RAL 9005 Matt	RAL 9005 Textured	RAL 9006 Matt	RAL 9006 Textured		

RAL colours available in a matt finish only

RAL 3002 Matt	RAL 3003 Matt	RAL 5000 Matt	RAL 5001 Matt	RAL 6000 Matt	RAL 6011 Matt	RAL 6020 Matt	RAL 6028 Matt	RAL 6033 Matt
RAL 7003 Matt	RAL 7009 Matt	RAL 7032 Matt	RAL 8008 Matt	RAL 8012 Matt	RAL 8015 Matt	White Matt		

RAL colours available in a textured finish only

RAL 1000 Textured	RAL 3000 Textured	RAL 5007 Textured	RAL 5008 Textured	RAL 5017 Textured	RAL 5023 Textured	RAL 6012 Textured	RAL 6017 Textured	RAL 6019 Textured
RAL 6021 Textured	RAL 6025 Textured	RAL 6027 Textured	RAL 6029 Textured	RAL 7000 Textured	RAL 7004 Textured	RAL 7010 Textured	RAL 7026 Textured	RAL 7043 Textured
RAL 7047 Textured	RAL 8003 Textured	RAL 8016 Textured	RAL 8025 Textured	RAL 8028 Textured	RAL 9001 Textured	RAL 9002 Textured	RAL 9003 Textured	RAL 9007 Textured
RAL 9010 Textured	RAL 9016 Textured	RAL 9017 Textured	RAL 9018 Textured					

RAL colours available in a metallic finish only

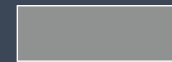

RAL 9007 Matt - DB
702 Akzo - Metallic

Wood effect finishes

T630	T631	T510	T800	T820	T830	T835
T850	T855	T860	T865	T870	T875	T880
T895	T900	T910	T930			

Designer finishes

T885 Carbon	T890 Corten	T905 Copper
T915 Ice Touch	T920 Concrete Dark	T925 Concrete Light



Model 400 Laminated black or white glass sheet bonded onto sash and frame, smooth design with no grooves. (Glass only applied externally, aluminium face internally)

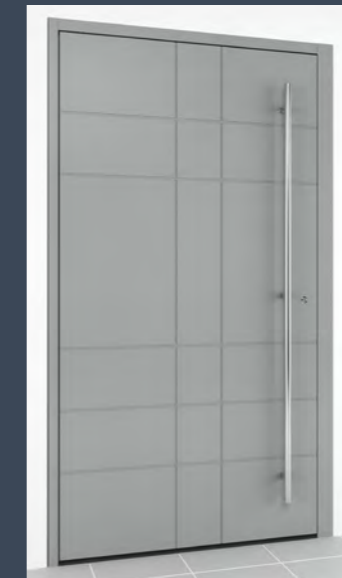

Model 404 Vertical and horizontal CNC grooves.



Model 408 Vertical and horizontal CNC grooves.

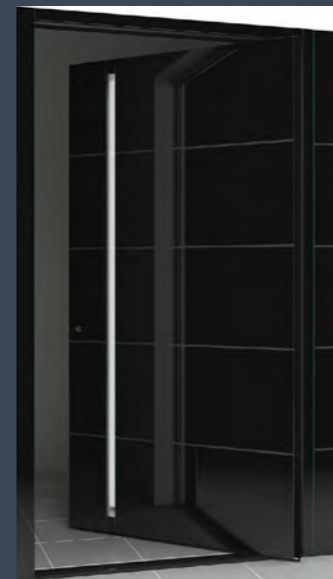

Model 402 Laminated black or white glass sheet bonded onto sash and frame, 4 horizontal grooves on door sash. (Glass only applied externally, aluminium face internally)



Model 405 Smooth design, no CNC grooves or lines.



Model 410 Vertical and horizontal CNC grooves.

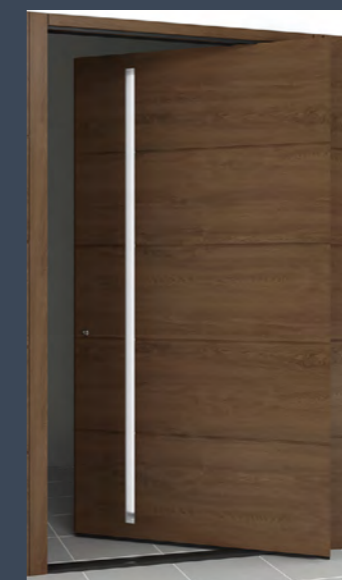

Model 406 Four horizontal CNC grooves.

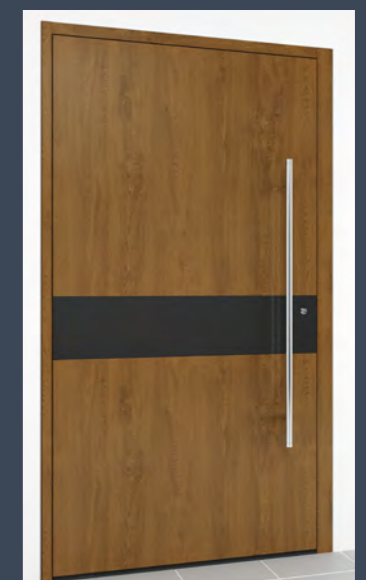

Model 416 Smooth design with option of contrasting décor colour.



10
YEAR
WARRANTY

2
YEAR
WARRANTY
ON ELECTRICS



Model 418
CNC grooves, glazed door. (Glass can be clear, full satin or satin with clear lines).



Model 424
CNC grooves, glazed door. (Glass can be clear, full satin or satin with clear lines).



Model 430
CNC grooves, glazed door. (Glass can be clear, full satin or satin with clear lines).

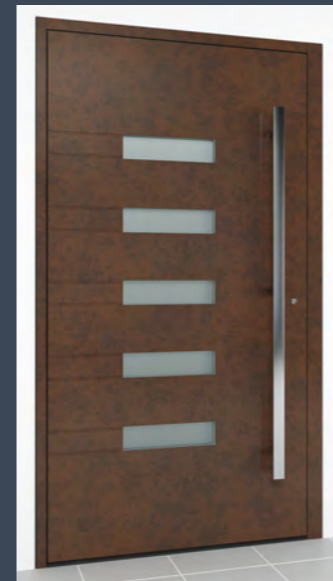

Model 436
CNC grooves, glazed door. (Glass can be clear, full satin or satin with clear lines).

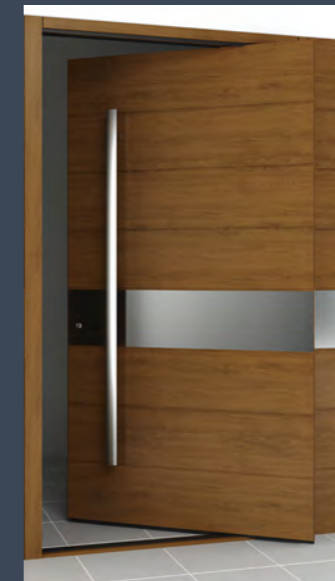

Model 442
CNC grooves with stainless steel décor.

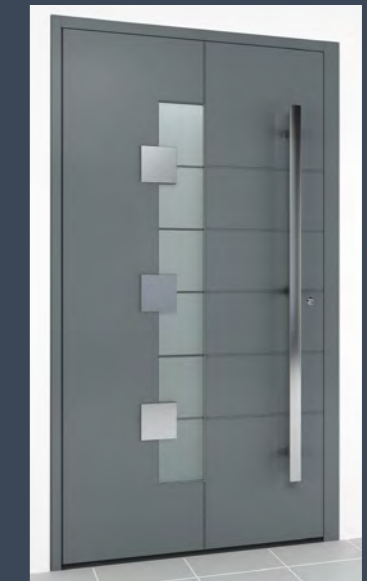

Model 450
CNC grooves with stainless steel next to the glazing (Glass can be clear, full satin or satin with clear lines).



Model 420
CNC grooves, glazed door. (Glass can be clear, full satin or satin with clear lines).



Model 426
CNC grooves, glazed door. (Glass can be clear, full satin or satin with clear lines).



Model 432
CNC grooves, glazed door. (Glass can be clear, full satin or satin with clear lines).

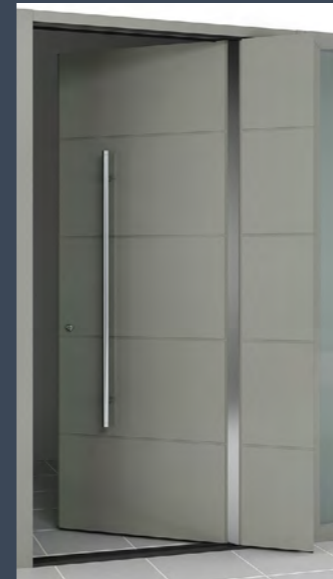

Model 438
CNC grooves with stainless steel.

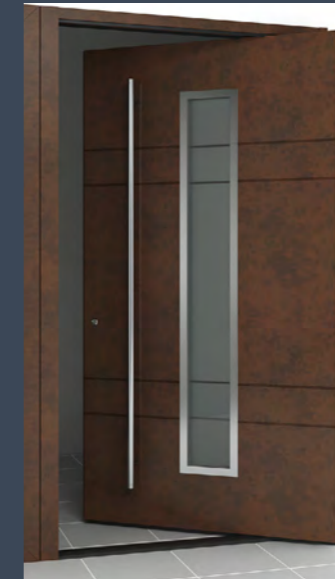

Model 444
CNC grooves with stainless steel around the glazing (Glass can be clear, full satin or satin with clear lines).

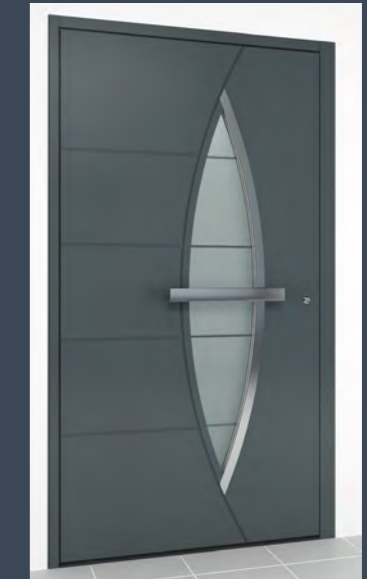

Model 452
CNC grooves with stainless steel next to the glazing (Glass can be clear, full satin or satin with clear lines).



Model 422
CNC grooves, glazed door. (Glass can be clear, full satin or satin with clear lines).



Model 428
CNC grooves, glazed door. (Glass can be clear, full satin or satin with clear lines).

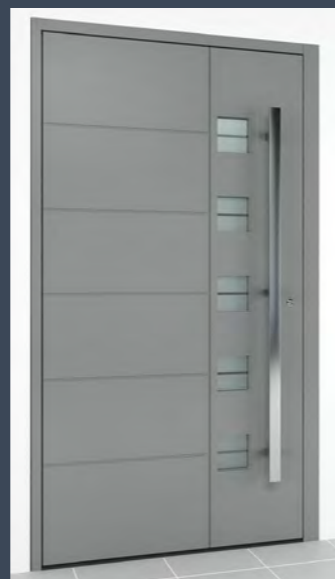

Model 434
CNC grooves, glazed door. (Glass can be clear, full satin or satin with clear lines).



Model 440
Vertical stainless steel lines with option of contrasting décor colour.

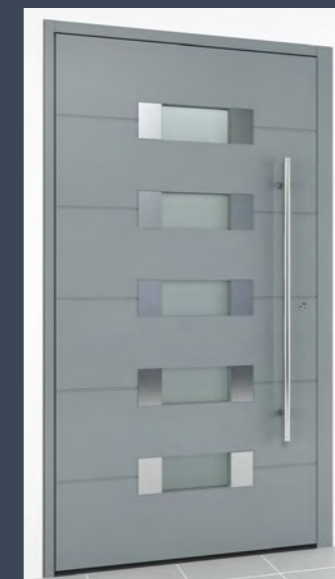

Model 448
CNC grooves with stainless steel next to the glazing (Glass can be clear, full satin or satin with clear lines).

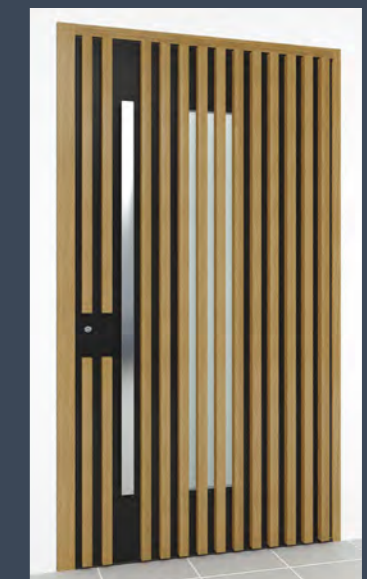

Model 466
Glazed 3D door design with 40mm x 40mm box sections bonded onto the outside of the door sash (Glass can be clear, full satin or satin with clear lines).

HOW PIVOT DOORS OPERATE

The pivot is a very simple mechanism which will give many years of trouble-free use because there is so little that can fail.

At the top of the hinge side, an elongated pin is embedded in the sash. At the bottom, a rotating baseplate is enclosed within the threshold, allowing the pivot door to operate effortlessly.

The pivot point is approximately 250mm in from the edge of the door sash, depending on the overall size of the door itself. Surprisingly for such huge doors they're very light to operate, a child can easily open and close them. We always recommend a concealed door closer to effectively 'soft close' the door.

A weatherbar will drop down under the door as the door closes, to form a seal with the threshold. Due to the almost completely flush detailing at the threshold, when installing a pivot in exposed locations we recommend that a non-permeable floor covering is used inside the door, to cope with potential drops of water ingressing.

CROSS-SECTION

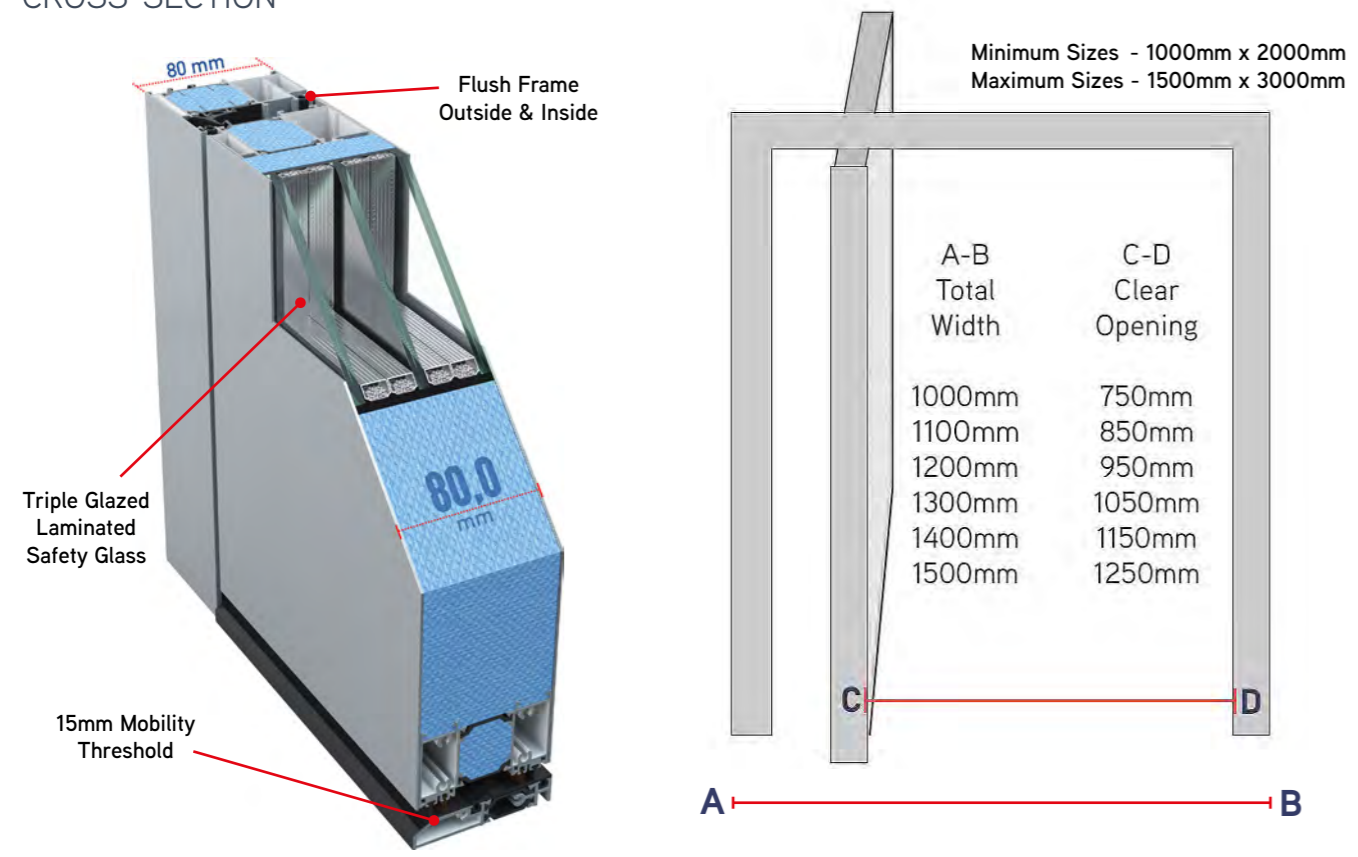

FRAME DETAIL

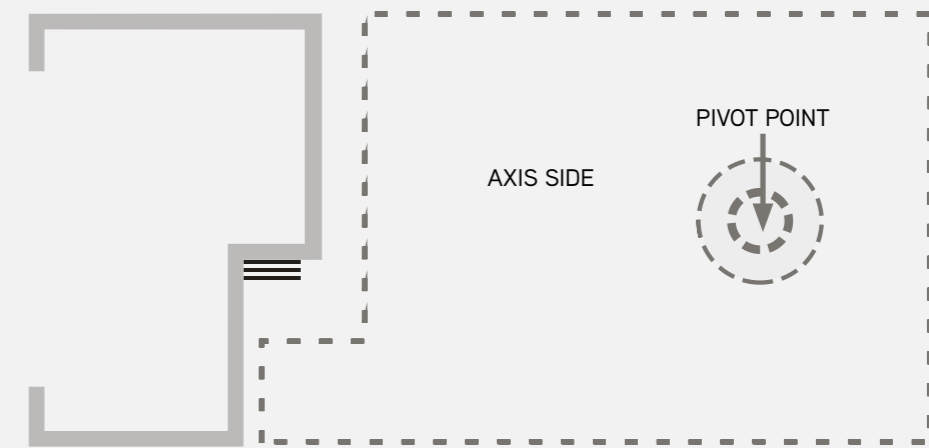

DOOR DETAIL

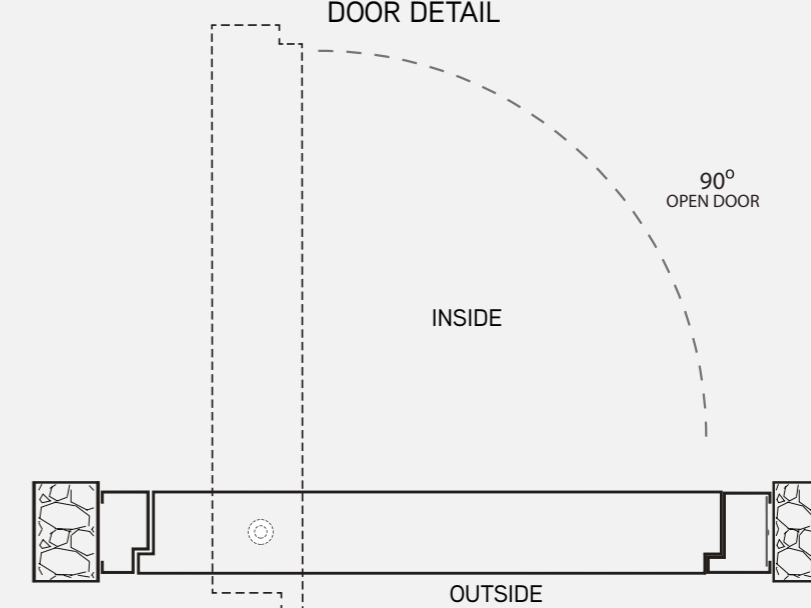

INWARD OPENING ONLY

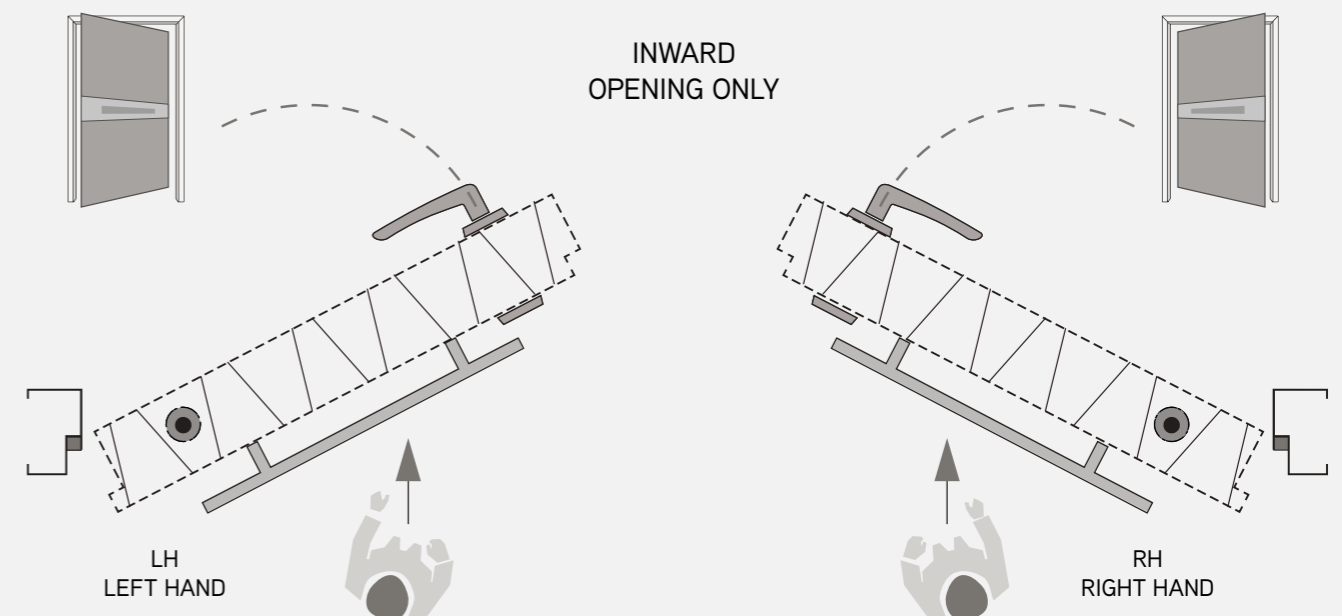



SPITFIRE
DOORS

THE ART OF PERFECTION

S-600 PIVOT DOORS